

Customer :
Project Name :
Project No. :
Revision No. :

SPECIFICATION for INDUCTION MOTOR



Contents

- | | |
|--------------------------------------|-----------|
| 1 . Data Sheet of AC Induction Motor | - 1Sheets |
| 2 . Speed-Torque & Current Curve | - 1Sheets |
| 3 . Outline Dimension Drawing | - 1Sheets |
| 4 . Main Terminal Box Drawing | - 1Sheets |

AC INDUCTION MOTOR DATA SHEET

Model No.or RFQ No.	3806KSTD40SSDS1STFE3351DL0SDS	Item No.		Rev. No.	[]		
Project Name		Project No.		Quantity			
GENERAL SPECIFICATION			PERFORMANCE DATA				
Frame Size	132M	Rated Output	7.5 kW	10 HP			
Type	HKP-7.5/4	Number of Poles	4				
Enclosure(Protection)	Totally Enclosed (IP55)	Rotor Type	Squirrel Cage				
Method of Cooling	IC411(FC)	Starting Method*	<input checked="" type="checkbox"/> D.O.L	<input type="checkbox"/> Y-Δ			
Rated Frequency	60 Hz	Rated Voltage	380 V				
Number of Phases	3	Current	Full Load	15.4 A			
Insulation Class	<input checked="" type="checkbox"/> F <input type="checkbox"/> B <input type="checkbox"/> H		Locked-rotor**	750 %			
Temp. Rise at full load (by resistance method)		Efficiency					
at 1.0 S.F	80 deg. C	50% Load		89.7 %			
Motor Location	<input checked="" type="checkbox"/> Indoor <input type="checkbox"/> Outdoor	75% Load		91.7 %			
Altitude	Less than 1000	100% Load		91.7 %			
Relative Humidity	Less than 80 %	Power Factor(p.u)					
Ambient Temp.	40 deg. C (Max.)	50% Load		0.660			
Duty Type	Continuous(S1)	75% Load		0.760			
Service Factor	1.15	100% Load		0.805			
Mounting	<input type="checkbox"/> B3 <input type="checkbox"/> B5 <input type="checkbox"/> V1 <input checked="" type="checkbox"/> B3/B5	Speed at Full Load		1760 r.p.m			
Bearing	Type	Anti-Friction					
	DE/N-DE	6208ZZC3 / 6208ZZC3					
	Lubricant	Grease(Polyrex-EM)					
External Thrust	Not applicable						
Coupling Method	<input checked="" type="checkbox"/> Direct <input type="checkbox"/> V-Belt	Moment of Inertia (J)					
Shaft Extension	<input checked="" type="checkbox"/> Single <input type="checkbox"/> Double	Load(Max.)		7.500 kg·m ²			
Terminal Box	Main	<input type="checkbox"/> Steel <input checked="" type="checkbox"/> Cast Iron	Motor		0.030 kg·m ²		
	Aux.	<input type="checkbox"/> Yes <input checked="" type="checkbox"/> No	Sound Pressure Level (No-load & mean value at 1m from motor)				
	Location	Refer to Outline Drawing					
Application		Vibration		1.6 mm/sec (r.m.s)			
Area classification	Not applicable	Permissible number of consecutive starts		Cold	3 times		
Type of Ex-Protection	Non-Hazardous			Hot	2 times		
Applicable Standard	KS, IEC, NEMA MG1 Part30(Vpeak)	Paint	Munsell No.	4.4PB5.5/5.6(VL-451)			
ACCESSORIES			SUBMITTAL DRAWING				
			Outline Dimension Drawing		Motor Weight(Approx.)		
			B3/B5	LM-T0133B4PL001	79 kg		
			Main T-Box Ass'y		3M-148549		
			REMARK				
			*.Premium Efficiency(IE3)				
			*.For use on PWM VFD 10:1VT,3:1CT@1.0S.F&F Temp.rise				
SPARE PARTS			Date	DSND	CHKD	CHKD	APPD
			2018-04-25	R.G. KIM	-	O.J. KIM	S.K. HAN

Note: Others not mentioned in this data sheet shall be in accordance with maker standard.
 Above technical data are only design values and shall be guaranteed with tolerance of applicable standard.
 Inspection and performance test shall be maker standard, if not mentioned.
 * In case of Inverter-Fed Motor, performance data is based on sine wave tests.
 ** The data are based on rated voltage & frequency, and data are expressed as a percentage of full load value.

Type :	HKP-7.5/4	
Full Load Torque :	4.2	kg.m
Motor moment of Inertia (J) :	0.030	kg.m ²
Load moment of Inertia (J) :	7.500	kg.m ²

7.5 kW	4 P	60 Hz
Speed at Full Load :		1760 RPM
Rated Voltage	380V	
Full Load Current	15.4A	

SPEED VS TORQUE & CURRENT CURVE

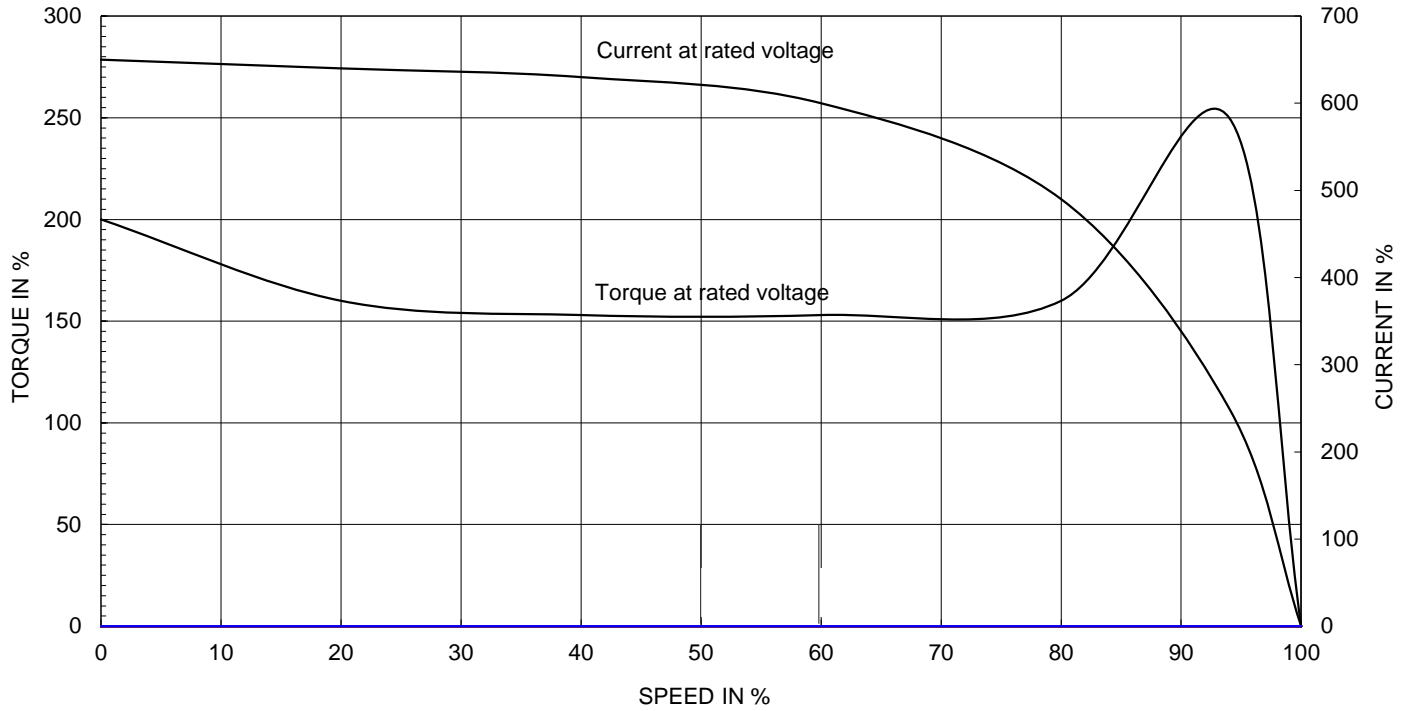

OUTPUT VS EFF., P.F & CURRENT CURVE

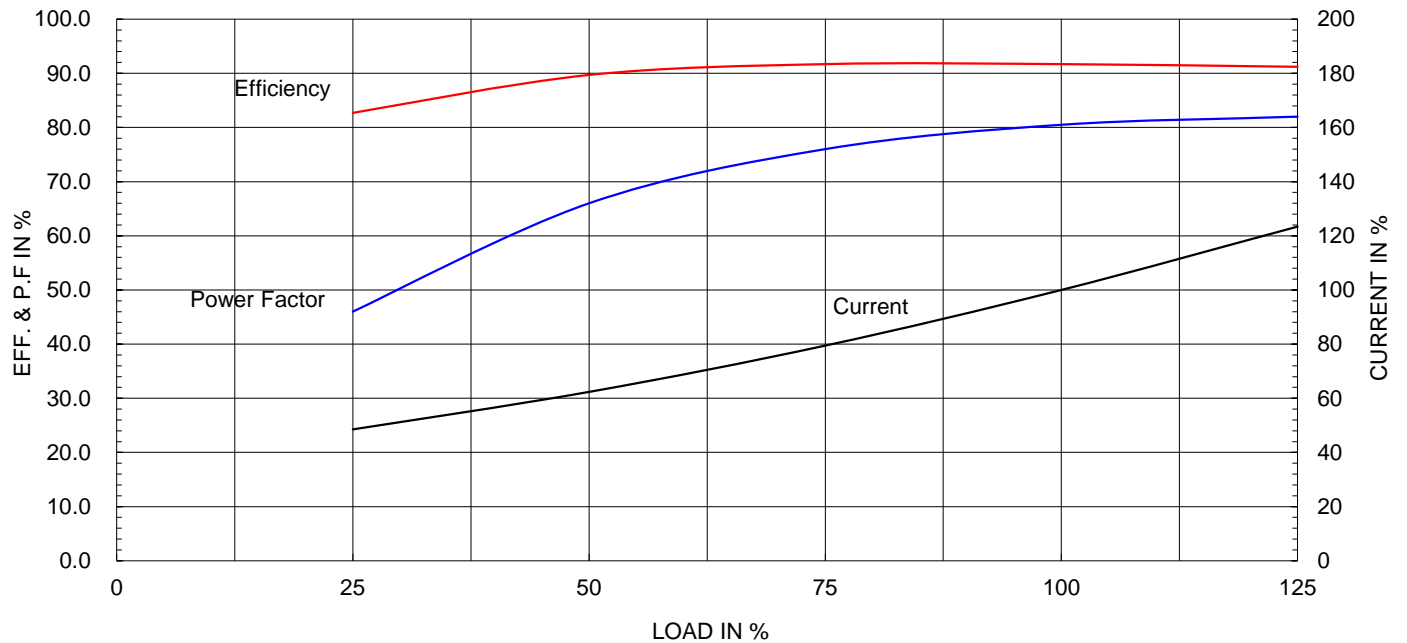

본 도면은 현대일렉트릭(주) 재산이므로
허가없이 복사할 수 없음 (취급주의)

THIS DRAWING IS PROPRIETARY TO HYUNDAI ELECTRIC. NO PART OF THIS DRAWING
MAY BE REPRODUCED WITHOUT THE PERMISSION OF HYUNDAI ELECTRIC.

	1	2	3	4				
▽	50S	REV	DATE	CONTENTS	REVD BY	CHKD BY	CHKD BY	APPD BY
▽▽	12.5S							
▽▽▽	3.2S							
▽▽▽▽	0.4S							

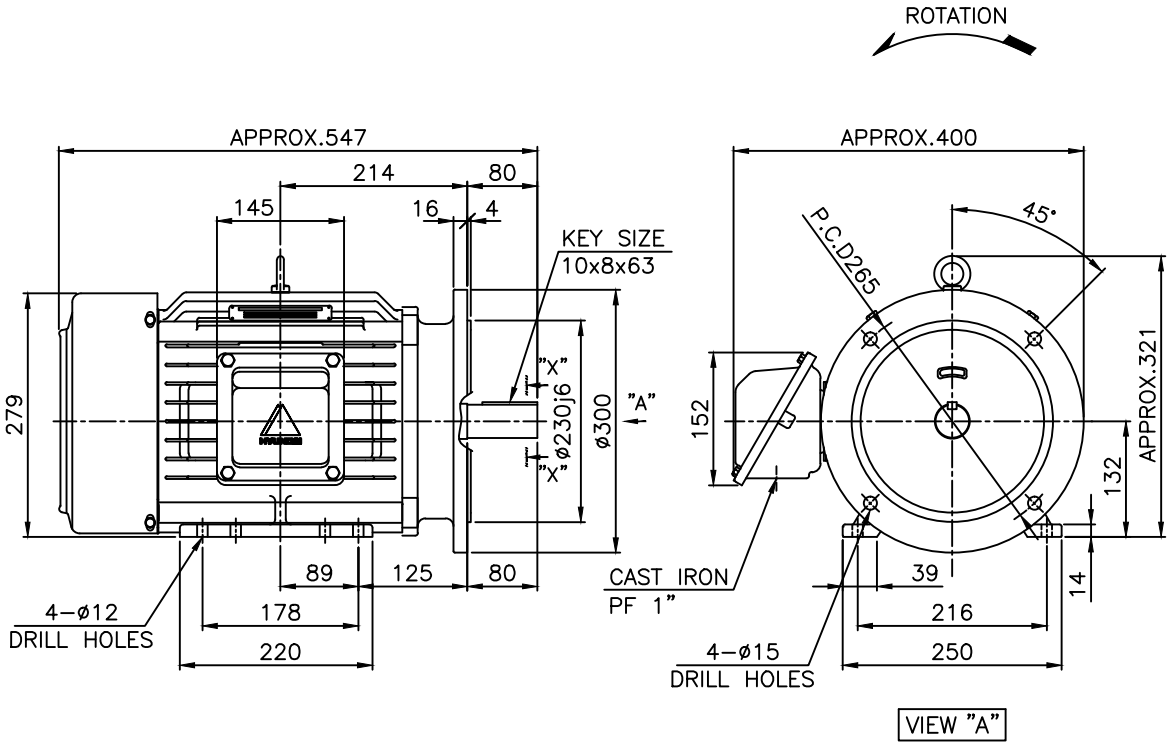

NOTE

1.TOLERANCE :

CENTER HEIGHT	132	0	-0.5
BASE HOLES	$\phi 12$	+0.43	0
FLANGE HOLES	$\phi 15$	+0.43	0
RABBET DIAMETER	$\phi 230$	+0.016	-0.013
SHAFT DIAMETER	$\phi 38$	+0.018	+0.002
KEYWAY WIDTH	10	0	-0.036
KEYWAY DEPTH	5	+0.2	0
KEY WIDTH	10	0	-0.036
KEY HEIGHT	8	0	-0.090

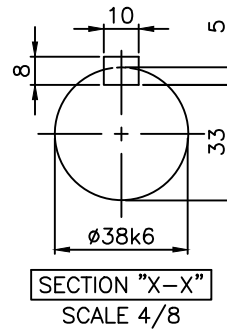

APPD BY	S.K.HAN	UNIT	mm	SUBJECT	KS, IEC Fr.132M(IE3, HK TYPE)	DWG SIZE	A4 (1:8)
CHKD BY	S.Y.KIM	SCALE	1/8	TITLE	OUTLINE		
CHKD BY	R.G.KIM	PROJEC'N	3각법(3rd Angle)	REF. NO		Sheet No.	of
DSND BY	S.H.YUN	DATE	2018-09-18	DWG NO	LM-T0133B4PL001	Revision No.	0

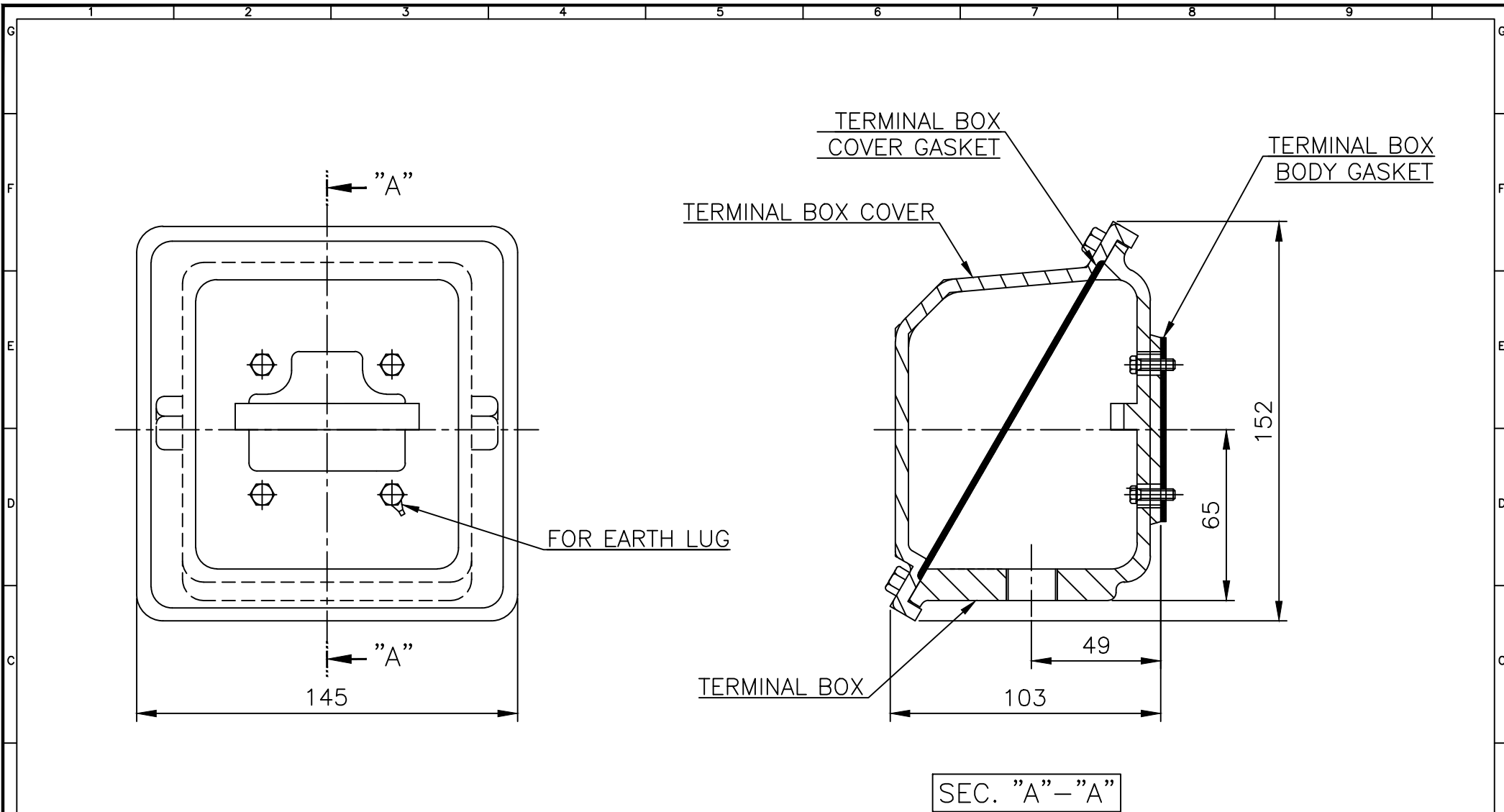

▽	50S
▽▽	12.5S
▽▽▽	3.2S
▽▽▽▽	0.4S

REV	DATE	CONTENTS	REVD BY	CHKD BY	CHKD BY	APPD BY

Q'TY	DESCRIPTION	MATERIAL	DIMENSION	WEIGHT	PART NO.	REMARK	NO.
APPD BY	S.K.HAN	UNIT	mm	SUBJECT	FR.100~132 (CAST IRON)	DWG SIZE	A3 (1:2)
CHKD BY	S.Y.KIM	SCALE	1/2	TITLE			
CHKD BY	R.G.KIM	PROJEC'N	3각법 (3rd Angle)	Terminal Box Arrangement			
DSND BY	H.K.LEE	DATE	2011-10-26	REF. NO	227B8004CB	Sheet No.	of
				DWG NO	3M-148549	Revision No.	2

일반가공공차		일반재공공차	
1-4	±0.1	6-30	±0.5
4-18	±0.2	30-120	±0.8
18-63	±0.3	120-315	±1.2
63-250	±0.5	315-1000	±2.0
250-	±0.8	1000-	±3.0