

Customer :
Project Name :
Project No. :
Revision No. :

SPECIFICATION for INDUCTION MOTOR



Contents

- | | |
|--------------------------------------|-----------|
| 1 . Data Sheet of AC Induction Motor | - 1Sheets |
| 2 . Speed-Torque & Current Curve | - 1Sheets |
| 3 . Outline Dimension Drawing | - 1Sheets |
| 4 . Main Terminal Box Drawing | - 1Sheets |

AC INDUCTION MOTOR DATA SHEET

Model No.or RFQ No.	2206KSTD40SSDS1STFE3V11DL0SD	Item No.		Rev. No.	[]	
Project Name		Project No.		Quantity		
GENERAL SPECIFICATION			PERFORMANCE DATA			
Frame Size	160M	Rated Output	15 kW	20 HP		
Type	HLP-15/2	Number of Poles	2			
Enclosure(Protection)	Totally Enclosed (IP55)	Rotor Type	Squirrel Cage			
Method of Cooling	IC411(FC)	Starting Method*	<input checked="" type="checkbox"/> D.O.L	<input type="checkbox"/> Y-Δ		
Rated Frequency	60 Hz	Rated Voltage	220 V			
Number of Phases	3	Current	Full Load	48.6 A		
Insulation Class	<input checked="" type="checkbox"/> F <input type="checkbox"/> B <input type="checkbox"/> H		Locked-rotor**	880 %		
Temp. Rise at full load (by resistance method)		Efficiency				
at 1.0 S.F	80 deg. C	50% Load		90.5 %		
Motor Location	<input checked="" type="checkbox"/> Indoor <input type="checkbox"/> Outdoor	75% Load		91.2 %		
Altitude	Less than 1000	100% Load		91.0 %		
Relative Humidity	Less than 80 %	Power Factor(p.u)				
Ambient Temp.	40 deg. C (Max.)	50% Load		0.820		
Duty Type	Continuous(S1)	75% Load		0.872		
Service Factor	1.15	100% Load		0.890		
Mounting	<input type="checkbox"/> B3 <input type="checkbox"/> B5 <input checked="" type="checkbox"/> V1 <input type="checkbox"/> B3/B5	Speed at Full Load	3535 r.p.m			
Bearing	Type	Anti-Friction				
	DE/N-DE	6309ZZC3 / 6309ZZC3				
	Lubricant	Grease(Polyrex-EM)				
External Thrust	Not applicable					
Coupling Method	<input checked="" type="checkbox"/> Direct <input type="checkbox"/> V-Belt	Moment of Inertia (J)				
Shaft Extension	<input checked="" type="checkbox"/> Single <input type="checkbox"/> Double	Load(Max.)		2.300 kg·m ²		
Terminal Box	Main	<input type="checkbox"/> Steel <input checked="" type="checkbox"/> Cast Iron	Motor		0.049 kg·m ²	
	Aux.	<input type="checkbox"/> Yes <input checked="" type="checkbox"/> No	Sound Pressure Level (No-load & mean value at 1m from motor)			
	Location	Refer to Outline Drawing				
Application		Vibration				
Area classification	Not applicable	Permissible number of consecutive starts		Cold	3 times	
Type of Ex-Protection	Non-Hazardous			Hot	2 times	
Applicable Standard	KS, IEC, NEMA MG1 Part30(Vpeak)	Paint	Munsell No.	4.4PB5.5/5.6(VL-451)		
ACCESSORIES			SUBMITTAL DRAWING			
		Outline Dimension Drawing		Motor Weight(Approx.)		
		V1	LM-T1163V1PL001	124 kg		
		Main T-Box Ass'y		3M-145860		
REMARK						
*.Premium Efficiency(IE3) *.For use on PWM VFD 10:1VT,3:1CT@1.0S.F&F Temp.rise						
SPARE PARTS						
		Date	DSND	CHKD	CHKD	APPD
		2018-04-25	R.G. KIM	-	O.J. KIM	S.K. HAN

Note: Others not mentioned in this data sheet shall be in accordance with maker standard.
 Above technical data are only design values and shall be guaranteed with tolerance of applicable standard.
 Inspection and performance test shall be maker standard, if not mentioned.
 * In case of Inverter-Fed Motor, performance data is based on sine wave tests.
 ** The data are based on rated voltage & frequency, and data are expressed as a percentage of full load value.

Type :	HLP-15/2	
Full Load Torque :	4.1	kg.m
Motor moment of Inertia (J) :	0.049	kg.m ²
Load moment of Inertia (J) :	2.300	kg.m ²

15 kW	2 P	60 Hz
Speed at Full Load :		3535 RPM
Rated Voltage	220V	
Full Load Current	48.6A	

SPEED VS TORQUE & CURRENT CURVE



OUTPUT VS EFF., P.F & CURRENT CURVE

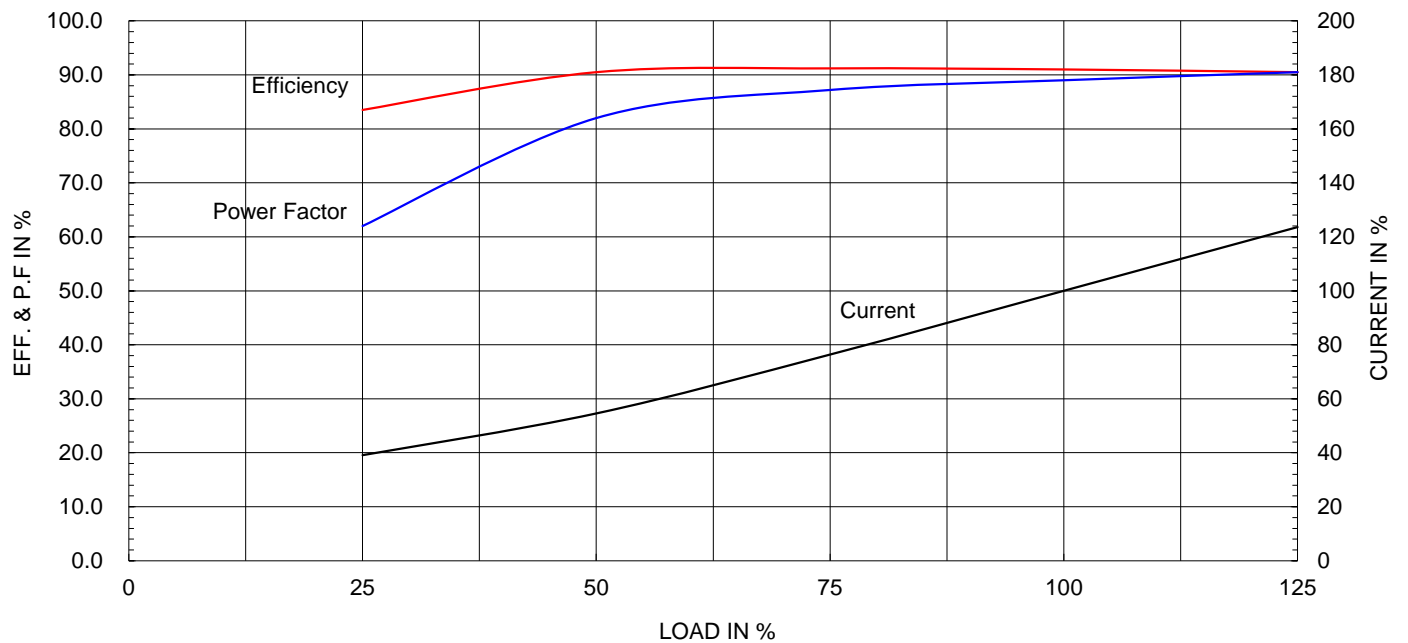

본 도면은 현대일렉트릭(주) 재산이므로
허가없이 복사할 수 없음 (취급주의)

THIS DRAWING IS PROPRIETARY TO HYUNDAI ELECTRIC. NO PART OF THIS DRAWING
MAY BE REPRODUCED WITHOUT THE PERMISSION OF HYUNDAI ELECTRIC.

	1	2	3	4				
▽	50S	REV	DATE	CONTENTS	REVD BY	CHKD BY	CHKD BY	APPD BY
▽▽	12.5S							
▽▽▽	3.2S							
▽▽▽▽	0.4S							

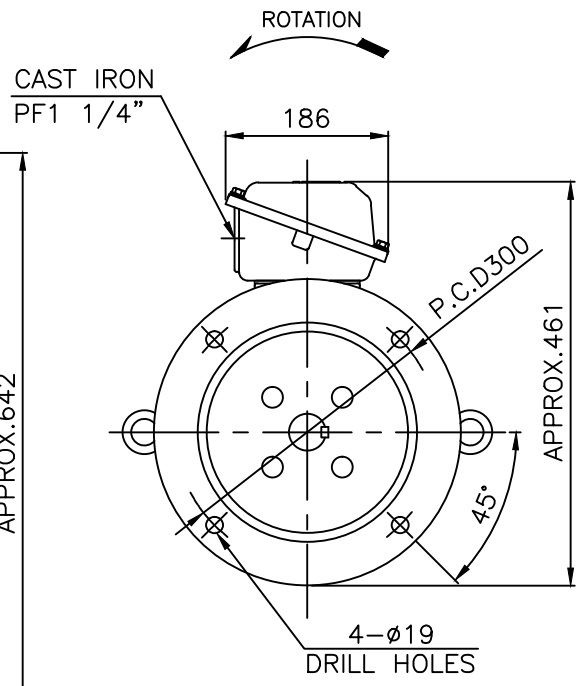
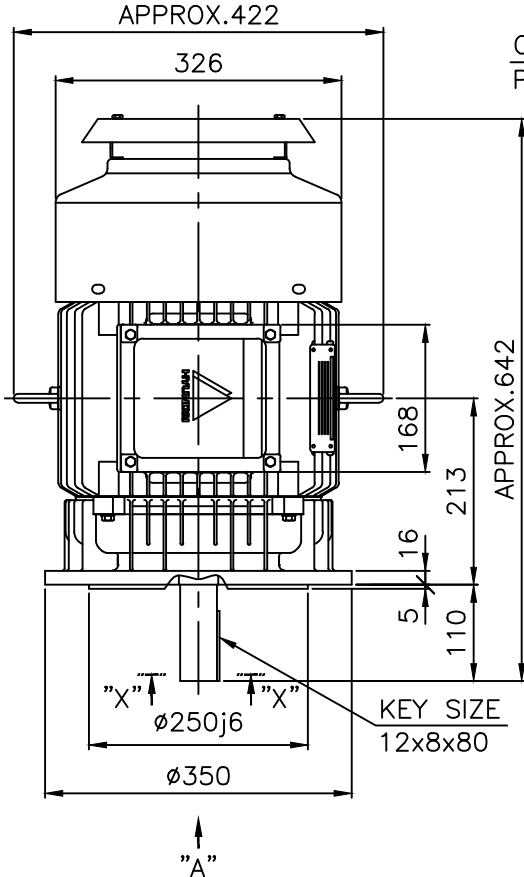

VIEW "A"

NOTE

1.TOLERANCE :

FLANGE HOLES	ø19	+0.52 0
RABBET DIAMETER	ø250	+0.016 -0.013
SHAFT DIAMETER	ø42	+0.018 +0.002
KEYWAY WIDTH	12	0 -0.043
KEYWAY DEPTH	5	+0.2 0
KEY WIDTH	12	0 -0.043
KEY HEIGHT	8	0 -0.090

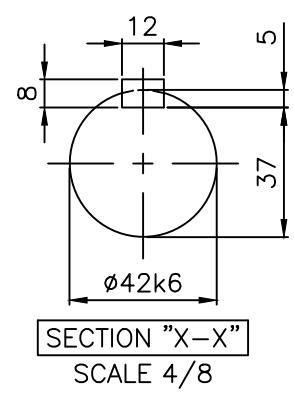

SECTION "X-X"
SCALE 4/8

APPD BY	S.K.HAN	UNIT	mm	SUBJECT	KS, IEC Fr.160M	DWG SIZE	A4 (1:8)
CHKD BY	S.Y.KIM	SCALE	1/8	TITLE	OUTLINE		
CHKD BY	R.G.KIM	PROJEC'N	3각법 (3rd Angle)	REF. NO		Sheet No.	of
DSND BY	S.H.YUN	DATE	2018-07-04	DWG NO	LM-T1163V1PL001	Revision No.	1





▽	50S
▽▽	12.5S
▽▽▽	3.2S
▽▽▽▽	0.4S

REV	DATE	CONTENTS	REVD BY	CHKD BY	CHKD BY	APPD BY	일반가공차		일반제관공차	
							1-4	±0.1	6-30	±0.5
							4-18	±0.2	30-120	±0.8
							18-63	±0.3	120-315	±1.2
							63-250	±0.5	315-1000	±2.0
							250-	±0.8	1000-	±3.0

Q'TY	DESCRIPTION	MATERIAL	DIMENSION	WEIGHT	PART NO.	REMARK	NO.
APPD BY	S.K.HAN	UNIT	mm	SUBJECT	FR.160~180 (CAST IRON)		DWG SIZE
CHKD BY	S.Y.KIM	SCALE	1/2	TITLE			A3 (1:2)
CHKD BY	R.G.KIM	PROJEC'N	3각법(3rd Angle)	Main Terminal Box Assembly			
DSND BY	H.K.LEE	DATE	2011-08-30	REF. NO.	227B8008LA2	Sheet No.	of
				DWG NO.	3M-145860	Revision No.	2