

Customer :
Project Name :
Project No. :
Revision No. :

SPECIFICATION for INDUCTION MOTOR



Contents

- | | |
|--------------------------------------|-----------|
| 1 . Data Sheet of AC Induction Motor | - 1Sheets |
| 2 . Speed-Torque & Current Curve | - 1Sheets |
| 3 . Outline Dimension Drawing | - 1Sheets |
| 4 . Main Terminal Box Drawing | - 1Sheets |

AC INDUCTION MOTOR DATA SHEET

Model No.or RFQ No.	2206KSTD40SSDS1STFE3B31DL0SDS	Item No.		Rev. No.	[]		
Project Name		Project No.		Quantity			
GENERAL SPECIFICATION			PERFORMANCE DATA				
Frame Size	80M	Rated Output	0.75 kW	1 HP			
Type	HLP-0.75/4	Number of Poles	4				
Enclosure(Protection)	Totally Enclosed (IP55)	Rotor Type	Squirrel Cage				
Method of Cooling	IC411(FC)	Starting Method*	<input checked="" type="checkbox"/> D.O.L	<input type="checkbox"/> Y-Δ			
Rated Frequency	60 Hz	Rated Voltage	220 V				
Number of Phases	3	Current	Full Load	3.4 A			
Insulation Class	<input checked="" type="checkbox"/> F <input type="checkbox"/> B <input type="checkbox"/> H		Locked-rotor**	750 %			
Temp. Rise at full load (by resistance method)		Efficiency					
at 1.0 S.F	80 deg. C	50% Load		76.5 %			
Motor Location	<input checked="" type="checkbox"/> Indoor <input type="checkbox"/> Outdoor	75% Load		81.0 %			
Altitude	Less than 1000	100% Load		83.5 %			
Relative Humidity	Less than 80 %	Power Factor(p.u)					
Ambient Temp.	40 deg. C (Max.)	50% Load		0.485			
Duty Type	Continuous(S1)	75% Load		0.610			
Service Factor	1.15	100% Load		0.702			
Mounting	<input checked="" type="checkbox"/> B3 <input type="checkbox"/> B5 <input type="checkbox"/> V1 <input type="checkbox"/> B3/B5	Speed at Full Load	1740 r.p.m				
Bearing	Type	Anti-Friction					
	DE/N-DE	6204ZZ / 6203ZZ					
	Lubricant	Grease(HIFLEX L-3)					
External Thrust	Not applicable						
Coupling Method	<input checked="" type="checkbox"/> Direct <input type="checkbox"/> V-Belt	Moment of Inertia (J)					
Shaft Extension	<input checked="" type="checkbox"/> Single <input type="checkbox"/> Double	Load(Max.)		0.625 kg·m ²			
Terminal Box	Main	<input type="checkbox"/> Steel <input checked="" type="checkbox"/> Cast Iron	Motor		0.002 kg·m ²		
	Aux.	<input type="checkbox"/> Yes <input checked="" type="checkbox"/> No	Sound Pressure Level (No-load & mean value at 1m from motor)				
	Location	Refer to Outline Drawing					
Application		Vibration					
Area classification	Not applicable	Permissible number of consecutive starts		Cold	3 times		
Type of Ex-Protection	Non-Hazardous			Hot	2 times		
Applicable Standard	KS, IEC, NEMA MG1 Part30(Vpeak)	Paint	Munsell No.	4.4PB5.5/5.6(VL-451)			
ACCESSORIES			SUBMITTAL DRAWING				
			Outline Dimension Drawing		Motor Weight(Approx.)		
			B3	LM-A1080B3P1001	12 kg		
			Main T-Box Ass'y		3M-148548		
REMARK							
*.Premium Efficiency(IE3) *.For use on PWM VFD 10:1VT,3:1CT@1.0S.F&F Temp.rise							
SPARE PARTS							
		Date	DSND	CHKD	CHKD	APPD	
		2018-04-25	R.G. KIM	-	O.J. KIM	S.K. HAN	

Note: Others not mentioned in this data sheet shall be in accordance with maker standard.
 Above technical data are only design values and shall be guaranteed with tolerance of applicable standard.
 Inspection and performance test shall be maker standard, if not mentioned.
 * In case of Inverter-Fed Motor, performance data is based on sine wave tests.
 ** The data are based on rated voltage & frequency, and data are expressed as a percentage of full load value.

Type :	HLP-0.75/4	
Full Load Torque :	0.4	kg.m
Motor moment of Inertia (J) :	0.002	kg.m ²
Load moment of Inertia (J) :	0.625	kg.m ²

0.75 kW	4 P	60 Hz
Speed at Full Load :		1740 RPM
Rated Voltage	220V	
Full Load Current	3.4A	

SPEED VS TORQUE & CURRENT CURVE



OUTPUT VS EFF., P.F & CURRENT CURVE

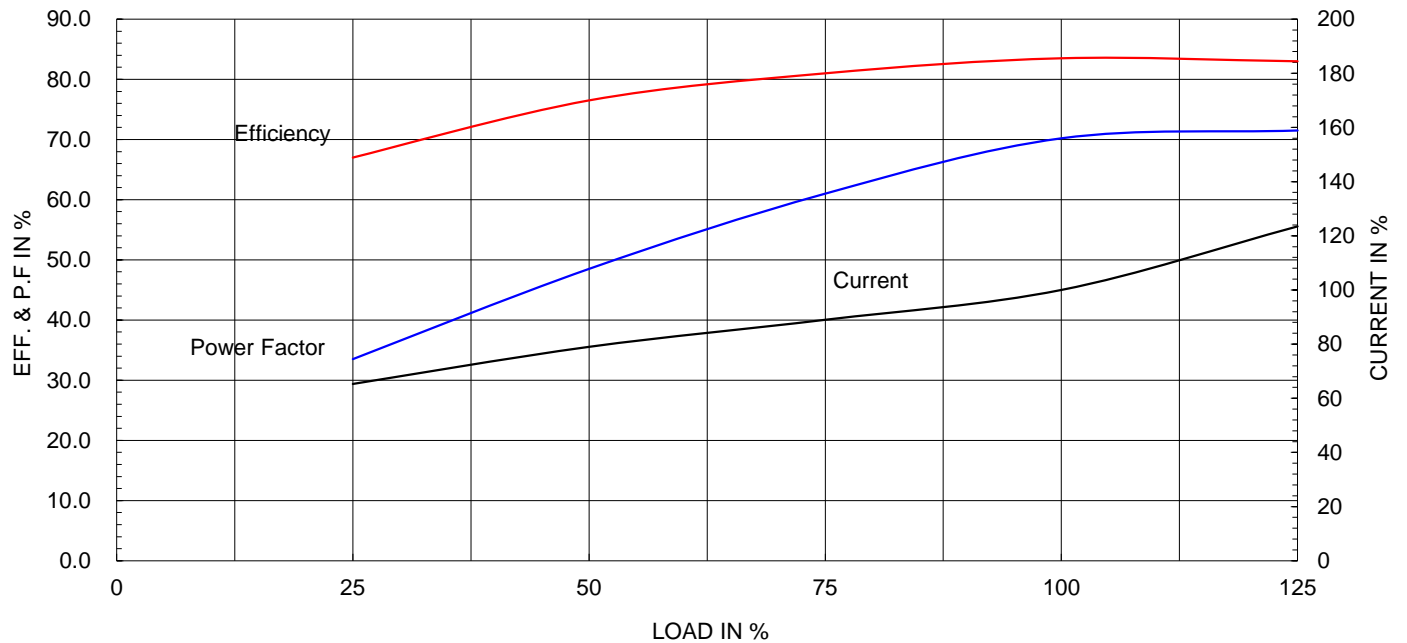

본 도면은 현대일렉트릭(주) 재산이므로
허가없이 복사할 수 없음 (취급주의)

THIS DRAWING IS PROPRIETARY TO HYUNDAI ELECTRIC. NO PART OF THIS DRAWING
MAY BE REPRODUCED WITHOUT THE PERMISSION OF HYUNDAI ELECTRIC.

	1	2	3	4				
▽	50S	REV	DATE	CONTENTS	REVD BY	CHKD BY	CHKD BY	APPD BY
▽▽	12.5S							
▽▽▽	3.2S							
▽▽▽▽	0.4S							

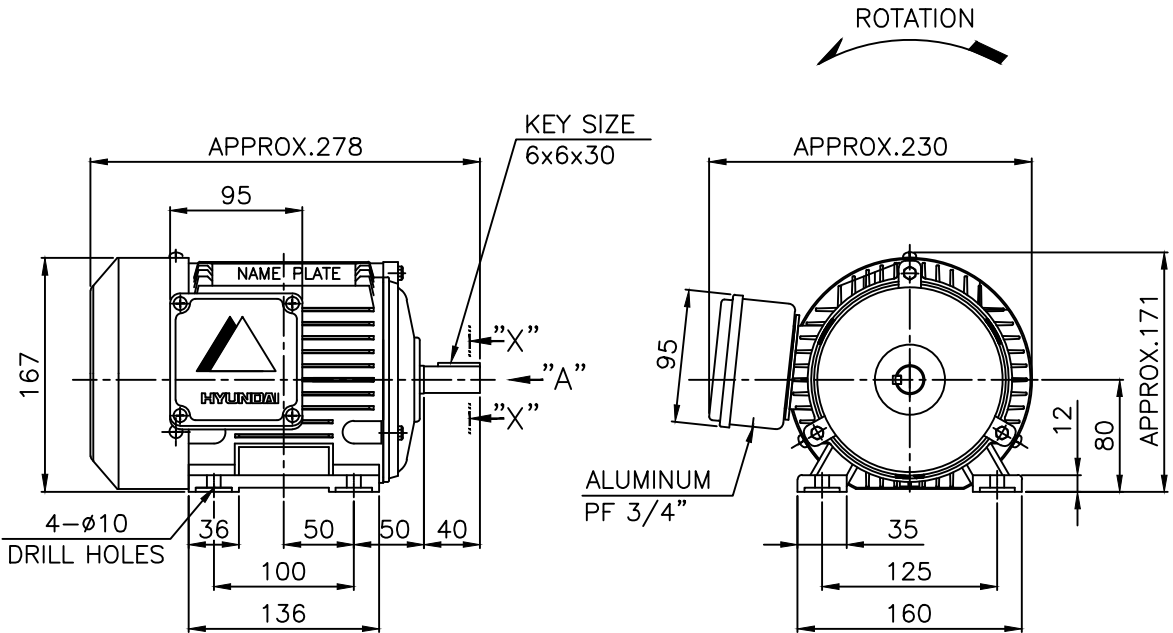

NOTE

1.TOLERANCE :

CENTER HEIGHT	80	$\frac{0}{-0.5}$
BASE HOLES	$\phi 10$	$\frac{+0.36}{0}$
SHAFT DIAMETER	$\phi 19$	$\frac{+0.009}{-0.004}$
KEYWAY WIDTH	6	$\frac{0}{-0.030}$
KEYWAY DEPTH	3.5	$\frac{+0.1}{0}$
KEY WIDTH	6	$\frac{0}{-0.030}$
KEY HEIGHT	6	$\frac{0}{-0.030}$

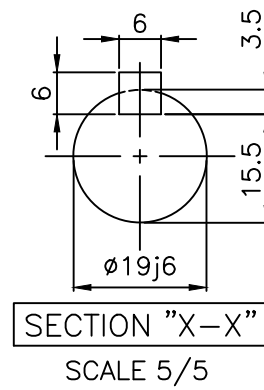

APPD BY	S.K.HAN	UNIT	mm	SUBJECT	KS, IEC Fr.80M	DWG SIZE	A4 (15)
CHKD BY	S.Y.KIM	SCALE	1/5	TITLE	OUTLINE		
CHKD BY	R.G.KIM	PROJEC'N	3각법 (3rd Angle)	REF. NO		Sheet No.	of
DSND BY	S.H.YUN	DATE	2018-06-14	DWG NO	LM-A1080B3P1001	Revision No.	0

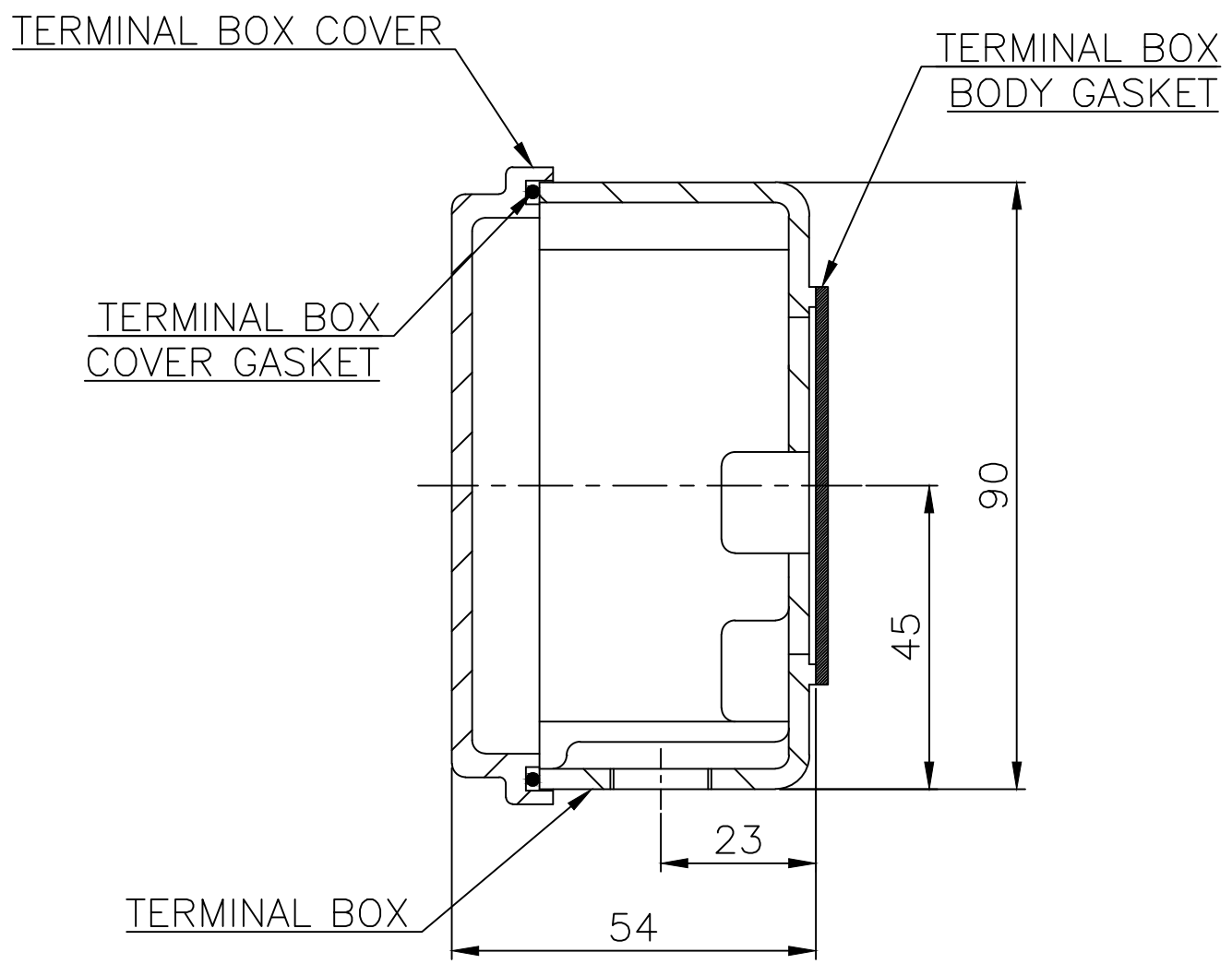
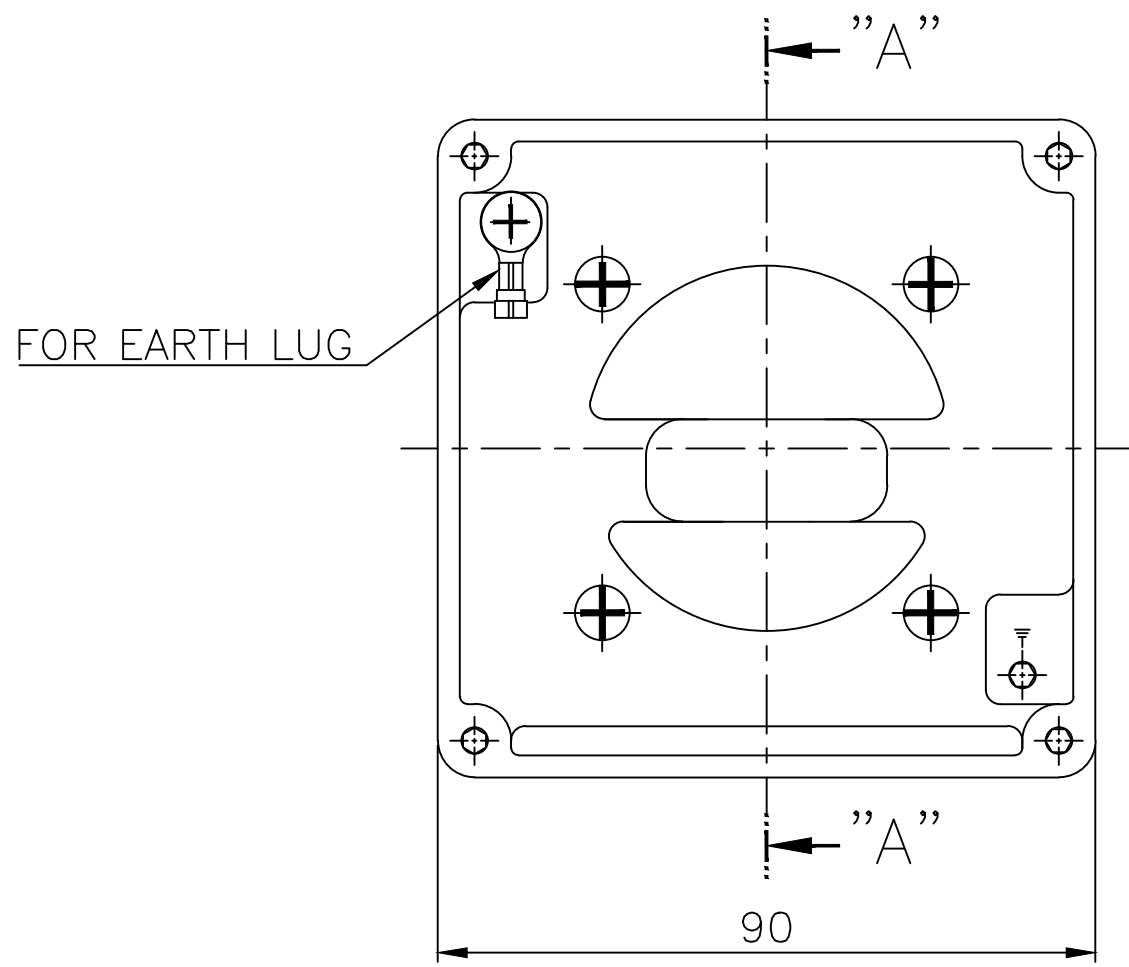

SEC. "A" - "A"

▽	50S
▽▽	12.5S
▽▽▽	3.2S
▽▽▽▽	0.4S

REV	DATE	CONTENTS	REVD BY	CHKD BY	CHKD BY	APPD BY

일반가공공차		일반계관공차	
1-4	±0.1	6-30	±0.5
4-18	±0.2	30-120	±0.8
18-63	±0.3	120-315	±1.2
63-250	±0.5	315-1000	±2.0
250-	±0.8	1000-	±3.0

Q'TY	DESCRIPTION	MATERIAL	DIMENSION	WEIGHT	PART NO.	REMARK	NO.
APPD BY	S.K.HAN	UNIT	mm	SUBJECT	FR.71~90 (AL)	DWG SIZE	A3 (1:1)
CHKD BY	S.Y.KIM	SCALE	1/1	TITLE Terminal Box Arrangement			
CHKD BY	R.G.KIM	PROJEC'N	3각법(3rd Angle)				
DSND BY	이혜경R	DATE	2011-10-26	REF. NO	227B1537AA	Sheet No.	of
				DWG NO	3M-148548	Revision No.	2